

NOTICE

Periodically wash the Transducer Face with soap and water to remove any oil film that may collect. Oil and dirt on the face will reduce sensitivity or may even prevent sounding.

GOT A PROBLEM? LET US HELP!

If you have a problem with your sonar unit, please give us a chance to help before sending it in for repair.

Assistance can often be extended by telephone or letter. Write or call one of our Authorized Service Centers or the Lowrance Electronics, Inc., Customer Service Department in Tulsa, OK. (Toll-free 1-800-331-3889).

Please detail the problem you are experiencing. Our Service Department may be able to save you the inconvenience of returning your unit.

If it is determined that your unit must be returned, full shipping instructions will be provided.

SCHEMATIC DIAGRAM AND PARTS LIST

Should you desire a Schematic Diagram and Parts list for your Lowrance TRUeline RECORDER, send \$1.00 to PARTS LIST, Lowrance Electronics, Inc., 12000 East Skelly Drive, Tulsa, Oklahoma 74128. Be sure and give us the Model Number and Serial Number of your SONAR INSTRUMENT.

INSTALLATION AND OPERATION MANUAL X-16 OWNER'S MANUAL

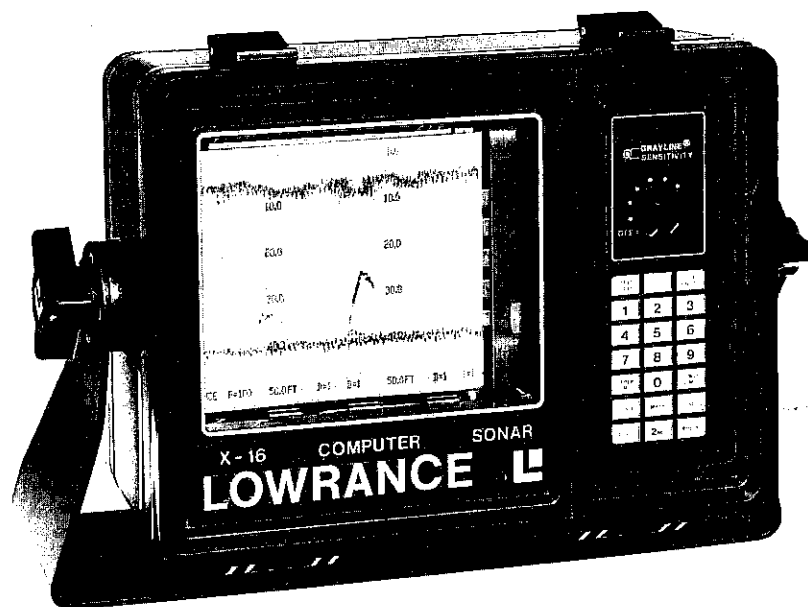

LOWRANCE ELECTRONICS, INC.
12000 E. SKELLY DR., TULSA, OKLA. 74128

INDEX

Specifications	1
Introduction	2
How it Works	2
Installation	2
Power Connections	3
Transducer Selection	4
Basic Operation	5
Sensitivity Control	5
Clear Entry	6
Discrimination	6
Paper Speed	7
GRAYLINE	7
Range	8
Lower Limit	8
Upper Limit	9
Lines	9
Marker	10
Scale	10
Memory/Reset	10
Feet, Fathoms, Meters	11
End Of Paper	11
Zero Adjust	11
How To Read Graphs	12
Paper Loading	13
Stylus Replacement	16
Stylus Belt Replacement	17
Maintenance	17
Troubleshooting	18
ADVANCED OPERATION	18
Surface Clarity Control (SCC)	18
Suppressor	19

SURFACE CLUTTER Algae, plankton, air bubbles, boat wakes, and schools of bait fish near the surface of the water can create large surface echoes on the paper. These echoes can extend far down the paper and interfere with fish or other target echoes.

Lowrance has a special feature called "Surface Clarity Control" or "SCC" that combats surface clutter effectively.

THERMOCLINE Junction of different temperature layers. When the warm and cool temperature layers meet, a discontinuity in the water is formed that reflects sonar signals. This is called a thermocline.

TRANSDUCER The "antenna" of a sonar unit. This contains a small crystal that converts the electrical energy from the transducer into sound energy and sends it into the water. It then converts any sound in its frequency range back into electrical pulses for the receiver. Transducers have a variety of styles including "Thru-Hull" which bolt thru a hole drilled in the hull, "Shoot-Thru-Hull" — epoxied directly to the inside of a solid fiberglass hull with no holes required, and "Transom Mount" — bolts directly to the transom of the hull, either below or flush with the bottom of the boat.

TRANSPORT ASSEMBLY The mechanism that holds and pulls the chart paper from the full paper roll, past the stylus, and rolls it up on the takeup side. It also contains the paper drive motor and gear train.

ACCESSORIES

LDT-3000 DIGITAL SURFACE TEMP

Allows instant visual reading of surface water temperatures from 32.0 to 99.9 degrees F. Includes heavy 28 foot sensor cable.

DUST COVER

Extra protection from the elements.

LSB-200A SWITCH BOX

Allows use of two different transducers with one sonar unit. Weatherproof switch activates transducer #1 or #2.

LSB-201A SWITCH BOX

Allows use of two sonars with only one transducer. Weatherproof switch activates sonar #1 or #2.

LXT-110A TRANSDUCER EXTENSION CABLE

Ten-foot extension cable for use where a transducer must be located beyond the reach of the standard transducer cable. Sonar unit does not need returning when only one extension is used.

LKB-2000 TRANSDUCER KICK-UP BRACKET

Allows THS 1192-20 to be mounted below the hull on aluminum boats to avoid hull turbulence.

LTB-1000 TRANSOM MOUNTING BRACKET

Transom mounting bracket and spat specifically designed for use with V-bottomed boats. Uses any Lowrance plastic bolt-thru-hull transducer.

LFF-102 FISH-N-FLOAT

Two highly visible floats with 100-foot nylon cord, wraparound lead sinkers.

LTP-100 FISH-N-TEMP

Portable temperature and depth indicator for accurate readings from 30-90 degrees F and depths to 80 feet.

LPG-605 CHART PAPER

Straight line chart paper, 50 foot roll, for all Computer Sonar graph recorders.

LTC-60 TRANSDUCER CONNECTOR KIT

Replaces old style transducer connector with new plastic style. Or to repair a damaged transducer cable.

LPB-192 POWER BOOSTER

Increases the output power of the X-15B to extend the depth range, better noise rejection, and increases the ability to display small detail.

LDT-4000 DIGITAL SURFACE TEMP

New sensor probe allows transom, thru-hull, or raw water intake mounting. Water temperature readings from 32.0 to 99.9 degrees F.

the sonar can separate two targets that are 1½ inches apart. This is considered good resolution. However, if a sonar pulse length was 500 micro-seconds, then the sonar could only separate targets that are at least 12 inches apart. That is why it is so important to pick a sonar unit that gives you the capability to change to narrow pulse lengths for good resolution. The X-16 allows pulse lengths down to 30 micro-seconds or one inch!

SECOND ECHO A second echo can appear on the display at roughly twice the depth of the actual bottom signal. This is caused by the transmitted signal travelling thru the water, reflecting off of the bottom, returning to the surface, reflecting off the surface, hitting the bottom once again, and finally striking the surface and the transducer. Actually, the sonar signal can do this many times as you can see if you are in shallow water and turn up the sensitivity. Sometimes three, four, or more echoes can be displayed.

SENSITIVITY The ability of a sonar unit to display targets. If a unit can display small targets deep in the water or very small detail, then it is said to have high sensitivity. A sensitivity control adjusts the level of the receiver for different conditions. Also called gain.

SCALE Depth markings printed on or near the chart paper. These can be shown in feet, fathoms, or meters. Often confused with Range.

SIGNAL-TO-NOISE RATIO The noise level divided by the signal level in a circuit is expressed by

the term signal to noise ratio. In sonar, a high signal to noise ratio is desirable because less noise suppression is required and it is easier for the unit to display only the true signals returning from the targets, rather than a mixture of signals and noise.

STYLUS This is the fine wire that does the actual marking on a graph recorder's paper. A high voltage is applied to the stylus which causes it to burn through the white outer coating of the paper, exposing the black carbon underneath. Use care when handling a stylus. Never touch it when the unit is operating.

STYLUS SKIP This is a condition that occurs when the stylus doesn't contact the entire surface of the chart paper. It then leaves gaps in the record where the stylus "skips" over spots. Usually, the problem can be rectified by removing and bending the stylus into the proper shape, although sometimes it is caused by a worn-out stylus which must then be replaced.

SUPPRESSOR A Lowrance exclusive, patented process to eliminate noise from a sonar unit's display. It works on the principal that noise pulses are typically short in duration. By increasing the transmitters pulse length, and tracking it with the receiver, the short noise pulses are cancelled out.

STYLUS BELT A belt that travels over two motor driven pulleys. It typically has a holder that retains the stylus and a magnet on the opposite side that triggers the transmitter.

Pulse	23
Alternate Transmit and Print	24
Paper Save	24
Print Intensity	25
Loran Interface	26
Power Booster	26
Summary of Commands	26
Glossary	27
Accessories	29

SPECIFICATIONS

Dimensions (with gimbal mount) .	10¼"W x 8¼"H x 6⅝"D
Dimensions (instrument only)	12¼"W x 9"H x 6⅝"D
Weight	8.5 pounds
Chart Paper	LPG-606 (2) 4" x 50' roll
Transmitter	
Frequency	192 kHz
Pulse Width (Adjustable)	30 μs - 2000 μs
Output Power	1600 watts p-p 200 watts RMS
Receiver Sensitivity	- 85 db
Chart Speed10 - 3.0 in/min
Voltage Range	10 - 15 vdc
Current Drain	1.5 amps, approximately
Fuse	4 amp

INTRODUCTION

The Lowrance X-16 is a highly sophisticated recording depth sounder. Thanks to a micro-computer, the X-16 can do more than any other sonar unit in its price range plus many that cost much more. Using the waterproof keyboard, full control of the system is at your fingertips to meet the changing demands of varying bottom conditions, water depth, and boat speed. You can select the unit's sensitivity, discrimination level, upper and lower depth range, paper speed, GRAYLINE, and many more features. The patented Lowrance variable suppression system combined with the new Discrimination feature not only filters out false signals without distorting the real ones, but is synchronized with the GRAYLINE function to provide clear signals under all conditions.

HOW IT WORKS

When the unit is turned on, an electronically regulated motor drives a lightweight belt located at the right edge of the recording paper. The stylus is attached to this belt. When the stylus is at the top of the paper a small mark is made. This is called the zero mark, and represents the surface of the water. The stylus continues

to move down the edge of the paper while the sound pulse is traveling through the water, and when an echo is detected, the stylus makes another mark on the paper. The depth of the object which reflected the echo can be read in feet, fathoms, or meters by comparing its location on the paper to the depth scale printed on the paper.

The paper speed is controlled by a variable speed motor. During one revolution of the stylus belt, a very narrow mark will be made by the flexible stylus, but the paper will move a small amount before the next revolution. Each mark will blend into the one before so that a composite "picture" of the target will be made, one tiny mark at a time.

INSTALLATION

Mounting —

The depth sounder may be installed in any convenient area, provided the unit can be tilted for the best viewing angle. Holes in the bracket base allow wood screw or bolt mounting. A wood stiffener may be required on the back of thin fiberglass panels to support the unit.

Make certain there is enough room on the back side of the unit to attach the power and trans-

ducer on the X-16. Because the transmitted power is greater, stronger signals are transmitted into the water. This will increase the depth range of the unit and the signal to noise ratio, plus the ability to see small detail is enhanced. For installation instructions on the LPB-192, read the owner's manual included with the power booster.

To turn the power booster on, press 12 - 2nd - 5.

To turn the power booster off, press 2nd - 8.

FREQUENCY CONVERTER

The Model LXC-16 frequency converter allows the X-16 to use either a 50 kHz or 192 kHz operating frequency at the discretion of the operator. It can be switched from 192 to 50 kHz at any time by using the keyboard. For installation instructions, see the owner's manual included with the LXC-16.

To turn the frequency converter on, press 2nd - 5.

To turn the frequency converter off, press 2nd - 8.

GLOSSARY OF TERMS

CAVITATION Air bubbles trapped against the transducer. This is typically caused by an improper transducer installation. Aluminum boats in particular have problems with cavitation. The problem is most evident when travelling at high speed. Air bubbles are created by rivets, strakes, ribs, or other objects which then pass over the face of the transducer. For the proper operation of the transducer, it must have solid contact with the water at all times.

MICRO-SECOND Unit of mea-

sure. One micro-second is equal to 0.001 second. Used in sonar to measure the amount of time the unit is transmitting. Abbreviation: μ s.

NOISE Any undesired signal. Noise can show up on a graph recorder as small dots or lines randomly scattered across the paper. It can be caused by electrical sources such as alternators, spark plugs, improper wiring, or by mechanical sources, air bubbles passing over the face of the transducer, vibration of the engine, or a loose transducer mounting.

OUTPUT POWER The amount of electrical energy applied to the transducer by the transmitter. Expressed in watts, typically the higher the output power a sonar unit has, the deeper it can read, and smaller detail can be shown.

POWER BOOSTER A device which connects to the transducer jack of the sonar unit and increases its output power.

PULSE LENGTH The length of time that the sonar unit transmits a pulse of sound into the water. This period of time is very short and is usually referred to in micro-seconds. Also called Pulse Width.

RANGE Maximum depth that a sonar unit is set to display. For example, a range setting of 0-60 feet on a graph means that the maximum depth that can be displayed before the bottom echo drops off the chart paper is 60 feet.

RESOLUTION The ability of a sonar unit to separate targets. This ability is determined by the pulse length of the unit. If the pulse length is very short, 50 micro-seconds for example, then

FIGURE 1

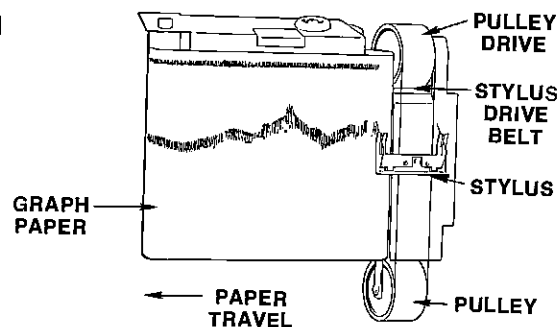

SUMMARY OF COMMANDS

COMMAND	FUNCTION	PRESS KEY:
CLEAR ENTRY	CLEAR	CLEAR ENTRY
ALTERNATE TRANSMIT	ON/OFF	UPPER & LOWER LIMIT
DISCRIMINATION	0-4	# - DISC
PAPER SAVE	0 - 7	# - 2nd - 6
PAPER SPEED	0 - 7	# - PAPER SPEED
POWER BOOSTER	ON/OFF	2nd - 5, ON/2nd - 7, OFF
PRINT INTENSITY	0 - 2	# - 2nd - LINES
SUPPRESSOR	0 - 7	# - 2nd - 9
SURFACE CLARITY (SCC)	0 - 7	# - SCC
FEET	ON	2nd - 1
FATHOMS	ON	2nd - 2
METERS	ON	2nd - 3

be used to help alleviate this condition.

LORAN-C INTERFACE

A remarkable advantage of the X-16 is its ability to print Loran-C coordinates in either Time Differences (TD's) or Latitude and Longitude. (**NOTE:** The X-16 has been designed to use only the Lowrance Loran-C receiver.) To connect the Loran to the X-16, simply splice the white and black wire on the X-16's power cable to the white and black wire on the Loran-C's power cable. (See Figure 2 on page 3.) After the proper connections have been

made, turn on both the Loran and the X-16. After the Loran has acquired the signals, press 2nd - 0. The Loran coordinates will immediately be printed vertically down the paper. Either Latitude and Longitude or Time Differences (TD's) will be printed on the paper depending on the mode the Loran is in. If 2nd - 0 is pressed and no Loran is connected, the unit will stop pulling paper and printing for approximately four seconds.

POWER BOOSTER

A power booster, Model LPB-192, is available that will increase the transmitter's output power of the X-16. It can be turned on or off by the keyboard

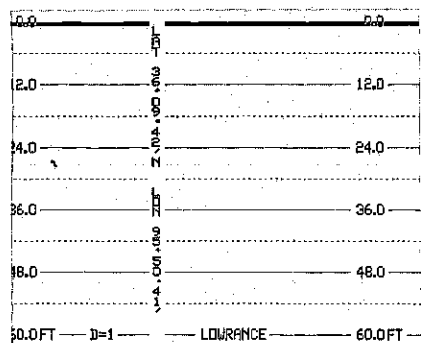

Figure 46



ducer cables. There should also be enough room to allow the front panel door to open.

If the desired location is closer than 18" to a magnetic compass, a trial run should be made with the unit in operation to be sure that the compass readings are not affected.

POWER CONNECTIONS

Twelve volt DC power for the depth sounder should be supplied by the boat's 12 volt electrical system. The power cable may be attached to an accessory or power buss, but if you have problems with electrical interference, the cable should be attached directly to the battery.

If a longer cable is required, use ordinary #18 lamp cord available at any hardware or electrical supply store. Splices should be soldered, however, if this isn't done, then use crimp-type splices. Tape all splices with electrical tape.

There are two types of noise that can be introduced into the sonar system if an improper installation is made, electrical noise picked up by the transducer or power cable, and acoustic noise picked up by the transducer.

Acoustic noise is caused by water turbulence, air bubbles

passing over the transducer, and cavitation where a partial vacuum is formed by the flow of water. This noise is minimized by following carefully the transducer installation instructions concerning location of the transducer.

Electrical noise is caused mainly by the boat engine's ignition system. Keep the transducer cable and power cable away from possible sources of electrical interference. Again, connect the power cable directly to the battery if possible, not the boat's wiring harness.

Cavitation and electrically induced noise can be generated if a careless installation has been made, but the Suppressor circuit and Discrimination is effective in combatting both. Before initial use or after prolonged storage, better water-to-transducer contact will be made if the face of the transducer is washed with mild detergent and warm water. Positive contact with the water is essential to reduce cavitation noise caused by bubbles on the transducer face.

An in-line fuse holder with a 4 amp fuse is supplied with the X-16. Be certain to install this as close to the power source (such as the boat battery or power buss) as possible. This will protect both the sonar unit and the power

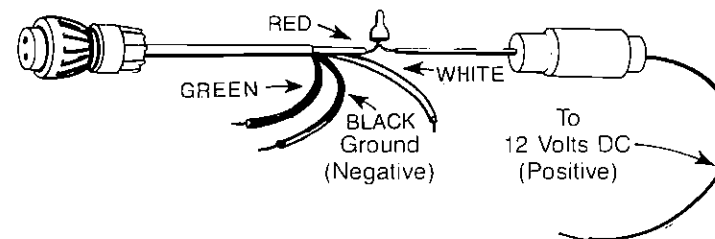

FIGURE 2

cable in the event a short occurs. Crimp connectors are supplied to attach the fuse holder to the power cable. The red wire in the power cable is the positive conductor. The black wire is the ground or negative conductor.

The graph is protected from accidental polarity reversals and no damage will occur if the wires are reversed. The unit will not operate until the proper polarity is applied.



FIGURE 3

When installing the power cable, you will find two extra wires coming from the power cable. The green one is for an optional Power Booster and the other white wire is for connection to a Loran C receiver. If neither of these features are going to be used, tape the ends of the green and white wires so that they cannot short. Refer to the Advanced Operation

section for more information on these wires.

TRANSDUCER SELECTION

Lowrance offers you the choice of transducers with either an 8 or 20 degree cone angle that will interchange with any of our 192 kHz sonar units. In other words, any Lowrance sonar instrument can be used with any Lowrance transducer of the same frequency without retuning of any kind, and no loss of performance. However, the use of any other manufacturer's transducer will result in a loss of performance.

Now you can select the transducer design and cone angle to best fit your specific needs. Generally, wide cone angle transducers (20 degrees) are ideally suited for operating in shallow water or at medium depths. The 20 degree cone angle allows you to see more of the underwater world. In 15 feet of water the 20 degree cone covers an area of the bottom that's about 6 feet across. The 8 degree transducer covers only about a 2 foot circle.

FIGURE 4

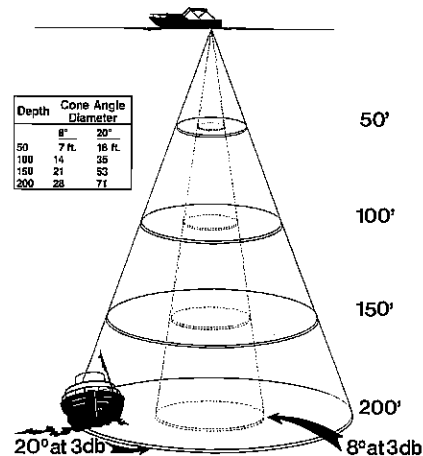

PAPER SAVE	
LEVEL	CHART SPEED REDUCED TO
1	1/2
2	1/3
3	1/4
4	1/5
5	1/6
6	1/7
7	1/8

way to slow the chart paper. The chart below gives the range of the Paper Save function and the amount that each level slows the paper.

To enable the Paper Save function, simply press the level of paper save desired, then 2nd, then 6. The paper should slow immediately. For example, suppose you wish to slow the paper down to 1/4 its present speed. Press 3 - 2nd - 6 and the paper will now be traveling four times slower than its previous speed.

When the Paper Save function is enabled, the X-16 will print PSV= and the level of paper save that you selected. For example, in our previous example the Paper Save value was 3. The X-16 will print PSV=3 on the bottom line of the chart paper. (See Figure 45.)

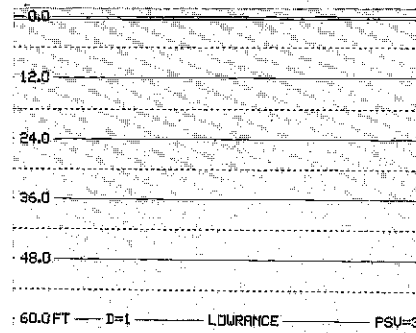

Figure 45

The Paper Save function can also be used with the Alternate Transmit and Print function which will cut any Paper Save speed in half. This gives fourteen different paper speeds selectable by the operator.

To disable the Paper Save function, simply press 0 - 2nd - 6, and the paper will speed up.

PRINT INTENSITY

Three levels of print intensity are provided for different conditions. The stylus printing can be adjusted to print lighter or darker by using the Print Intensity mode. When the X-16 leaves the factory, the Print Intensity is set to level 1. To change this setting, press the level of intensity desired, from 0 to 2 (0 is lightest, 2 is darkest) and then press 2nd - LINES.

For example, if the stylus is printing too light, press 2 - 2nd - LINES and the markings on the chart paper should become darker.

This feature is useful when a stylus becomes old. By using the "2" level or darkest level, the printing can improve. If, when using very slow paper speeds, the record has much overprint due to multiple stylus strikes in a small area, the "0" or lightest level can

keyboard the initial pulse length desired and then press the PULSE key. For example, to set the initial transmit pulse length to 100 micro-seconds, press 1 - 0 - 0 - PULSE. This will override the micro-computer's selection and set the initial transmitter pulse length to 100 micro-seconds. P = 100 will be printed at the bottom of the paper to signify that the entry has been confirmed. (Note: When an initial transmit pulse length is set, this length will be fixed for all depth settings until changed.)

To return control back to the micro-computer, press 0 - PULSE and the micro-computer will select the initial pulse length.

ALTERNATE TRANSMIT AND PRINT

When using the X-16 in deep water, or if you wish to simply conserve paper, it may be desirable to slow the paper speed even more than the automatic system allows. However, when doing so, you may get "over print" or very dark, heavy printing over an area that is difficult to read. Much detail can also be lost due to this.

A feature that is available on the X-16 is the Alternate Transmit and Print function which, when activated, causes the stylus to print every other revolution instead of every revolution. This accomplishes four things:

1. Since the stylus only prints every other revolution, the recorded information doesn't have the "over print" problem, therefore good records are attainable at slower paper speeds. Also, the scale numbers are spread out more, making them more legible.
2. Reduces the possibility of

"wrap-around". This is the undesirable occurrence of the second or third bottom echo printed on the paper at the top or middle of the page. Many times this can interfere with fish or other targets that you wish to see.

3. Reduces the reverberation effect. This happens mainly on lower frequency units, but it can happen on higher frequency models. Reverberation is heavy, scattered noise marks caused by the transmitted signal becoming trapped between the surface and the bottom, usually scattered in heavy plankton layers or baitfish schools. This causes a great many lines to be printed on the page. By enabling the Transmit and Print function, the transmitter is triggered only half as many times as normal, putting less energy into the water (same amount of transmitter power, just not as often) which reduces the amount of noise seen.

4. Divides the paper speed by two. A significant amount of paper can be saved by using the Alternate Transmit and Print feature.

To turn this feature on, simply press the 2nd key, then press the "4" key. The paper speed will immediately slow down, signifying that the function is enabled.

To turn the Alternate Transmit and Print feature off, simply press the 2nd key and then press the "7" key. The paper speed will immediately speed up, signifying that the function has been turned off.

PAPER SAVE

Although the Alternate Transmit and Print function will slow the paper speed, the Paper Save function is an even more powerful

Thus, you would use a 20 degree transducer when looking for fish or structure, to easily find drop-offs or reefs, and to see fish that are around you . . . not just below you. However, the 20 degree transducer won't penetrate to greater depths as well as the 8 degree transducer, nor will it show a sharp drop-off as well. In a deep-water environment (100 feet or deeper) or where you're looking at sharp drop-offs, the narrow cone angle can sometimes be more desirable because it can more accurately detect the location of the drop-off without displaying the fish. In deep water, with the sound energy being concentrated in a smaller area, the 8 degree transducer can reach to greater depths.

Both the 8 degree and the 20 degree transducers give accurate bottom readings, even though the bottom signal is much wider on the 20 degree model because you are seeing more of the bottom. Remember, the shallow edge of the signal shows you the true depth. The rest of the signal tells you whether you are over rocks, mud, dropoffs, etc.

Thanks to the LSB-200A transducer switch box, you can have the best of both worlds. By installing the LSB-200A near the operator, both a 20 degree and an 8 degree cone angle transducer may be mounted on a boat and connected to the switch box. A cable from the switch box is then connected to the X-16. Now either transducer may be used as conditions dictate. Use the 20 degree transducer when in shallow to medium depths and then switch to the 8 degree transducer

when in deep water or when you need just navigation information.

Salt water boats need to have the transducer painted with a thin coat of anti-foulant paint to prevent organisms from growing. If unchecked, barnacles and other marine growth will cause a decrease in the transducer's sensitivity. Do not use a metal based anti-foulant paint as it will decrease the transducer's sensitivity also. There are special paints on the market specifically designed for transducers and are carried by most marine dealers.

BASIC OPERATION

On-Off and Sensitivity Control —

Rotate the Sensitivity knob clockwise to turn the unit on. The Sensitivity knob works much like the volume control on a radio, that is, weaker signals will be detected with higher settings of the knob. When cruising, or at other times when just simple bottom contour information is desired, the Sensitivity setting can be low. In deep water or over soft, muddy bottoms, (which produce weak echoes), the setting will have to be higher.

When high Sensitivity settings are used, a second bottom echo will appear. This is normal and is caused by the returning signal reflecting off the surface of the water, making a second trip to the bottom and back.

If detailed information about brush piles, individual fish, or the thermocline is desired, the Sensitivity knob should be rotated to approximately the ¾ point. Refer to the illustrations on page 6 to see what effect the Sensitivity control setting has on the recorded information.

Recording individual fish with an "arched" signature can usually be accomplished at trolling speed with the Sensitivity knob at the $\frac{3}{4}$ point, or higher. Refer to the section "Arched Signatures" for more information about this important function of the recorder.

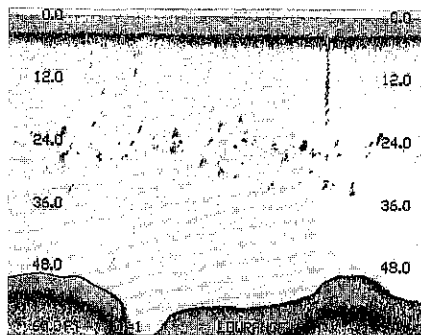

FIGURE 5 SENSITIVITY: TOO LOW

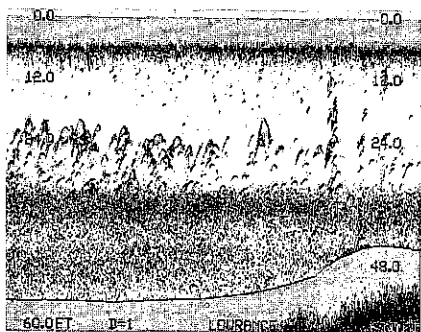

FIGURE 6 SENSITIVITY: PROPER SETTING

CLEAR ENTRY

The CLEAR ENTRY key is used when a mistake has been made when entering a command to the unit. If, for example, you wish to set the lower depth limit to 500 feet, and by accident, you press 509. BEFORE you press the LOWER LIMIT key, you can press the CLEAR ENTRY key which erases the mistake, and allows you to re-enter the correct command.

DISCRIMINATION

Noise pulses are the largest complaint most often received about sonar units. Lowrance has had the patented Suppression system for many years which is quite effective at eliminating noise from the display. The only drawback to the Suppression system is that it increases the transmitter's pulse length which decreases resolution and causes targets that are close together to merge into one "blob" instead of two distinct images.

Discrimination is a program installed in the X-16's micro-processor that enables it to process the output from the receiver, determine which signals are noise and eliminate them, then print only the legitimate echoes.

Using this concept, the transmitted pulse does not have to be increased, therefore records with high resolution and high noise immunity can be achieved.

Discrimination is interlaced with Suppression, however, and some suppression is used when higher levels of Discrimination are chosen. For a complete explanation of Suppression and Discrimination, see the Advanced Operation section entitled "Suppression". There are five levels of Discrimination that can be used. (0) is the lowest level whereas the highest value (4) is the strongest level and should be used only when severe noise is present.

Another advantage of Discrimination is its ability to filter out interference from other depth sounders. This allows the simultaneous operation of a digital depth sounder and the X-16. Turn both units on. If interference from

Suppressor level by using the Suppressor control at any level above 3. The Suppressor control will override the automatic selection that Discrimination chose. If a suppression level greater than 0 is selected by the operator, then the X-16 will print an "F" after the Discrimination level. For example if the Discrimination level is 1 and the Suppressor level is set (or "fixed") to 3, then the X-16 will print "D=1F". This is a reminder that some level of suppression is in use. (See Figure 43.)

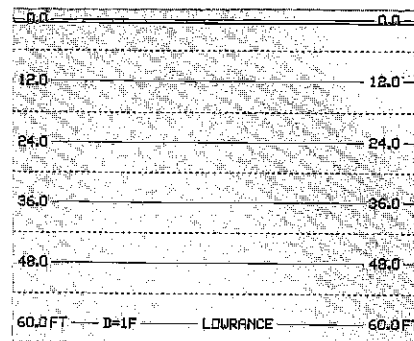

FIGURE 43

PULSE

In the Suppressor section of this manual, we explained the relationship between pulse length and target separation. As pulse length increases, target separation. As pulse length increases, target separation or resolution is degraded but deep water penetration improves. However, if the pulse width is decreased, resolution becomes much better. The X-16 allows you to take advantage of this fact by making it possible to override the initial transmitter pulse length setting from what the micro-computer selects according to the Lower Limit.

The initial transmitter pulse length can be set from 30 μ s to

1700 μ s by entering it on the keyboard. By setting the initial transmitter pulse with to 100 μ s, a three inch resolution is obtained, 50 μ s equivalent to an inch and a half, and 30 μ s initial transmit pulse length is equal to one inch resolution! No other graph recorder in the market today can give you this feature. After setting the initial transmitter pulse length, the Discrimination function can be used to eliminate noise and still have good resolution.

The X-16 will display the initial transmitter pulse length at the bottom of the paper when you over-ride the micro-computer. To distinguish the initial transmitter pulse from the other information printed on the paper, the graph will print P=100 (if the pulse is set to 100 micro-seconds.) A 50 μ s initial pulse length would be displayed as P=50. (See Figure 44.)

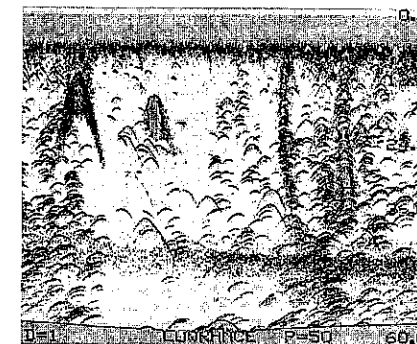

Figure 44

NOTE: If a pulse length 110 micro-seconds or less is chosen by the operator, the Suppressor is disabled. Also, less than maximum power is transmitted when the pulse length is less than 100 micro-seconds.

To set the initial transmitter pulse length, simply press on the

SUPPRESSOR LEVEL	INITIAL TRANSMIT PULSE INCREASE (micro-seconds)
0	AUTOMATIC
1	0
2	100
3	200
4	330
5	450
6	600
7	800

IF INITIAL TRANSMIT PULSE LENGTH IS LESS THAN 500 MICRO-SECONDS:

DISCRIMINATION LEVEL	SUPPRESSOR LEVEL
0	1
1	1
2	2
3	3
4	4

IF INITIAL TRANSMIT PULSE LENGTH IS GREATER THAN 500 MICRO-SECONDS:

DISCRIMINATION LEVEL	SUPPRESSOR LEVEL
0	1
1	2
2	3
3	4
4	5

is automatically increased when the Discrimination level is increased. This is done for better noise rejection. The following chart shows the relationship between Suppression and Discrimination. Remember, Suppressor value 1 adds nothing to the initial transmit pulse length.

In other words, if the lower limit selected was 525 feet and a Discrimination level of 2 was

selected, the transmit pulse length would be: $525 + 200 = 725$ micro-seconds. We added the initial transmit pulse of 525 micro-seconds which is listed in the initial transmit pulse chart, to 200 micro-seconds, which is Suppressor level 3, according to the Discrimination - Suppressor chart. So the total initial transmit pulse length is 725 micro-seconds. Now, if we want, we can increase the

the digital shows up on the X-16 (random short lines running vertically across the paper), then increase the Discrimination level until they are gone.

To use the Discrimination function, simply press the level of noise rejection desired, from 0 to 4, then the Disc (Discrimination) key. There should be an immediate change in the amount of noise present on the paper. The Discrimination setting is printed at the bottom of the paper each time the level is entered and at intervals thereafter. When the X-16 is shipped from the factory, the Discrimination level is set to 1.

The Discrimination function can be disabled at any time by pressing 0 - DISC.

Example: Enter a Discrimination level of 4.

FIGURE 7

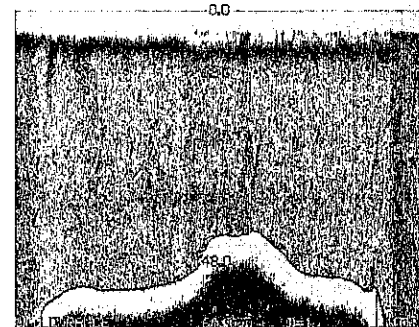

PRESS: 4 - DISC FIGURE 8

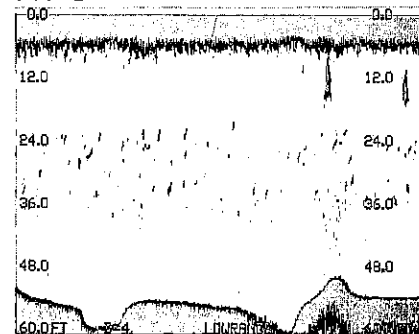

PAPER SPEED CONTROL

This key adjusts the speed of the chart paper. Its range is 0 to 7. When the X-16 is first turned on, the paper speed is set to level 5. This setting is good for detailed graphs, in shallow to medium depths when trolling.

It will show proper fish arches at low speeds and keeps high speed information from being compressed. The paper speed should be turned down when using the unit in deep water. This will prevent gaps from appearing in the record. In fact, the microcomputer will automatically slow the maximum speed of the chart paper when operating in deep water.

To change the speed of the chart paper, simply press the new level desired, from 0 to 7, then press the PAPER SPEED key. The paper speed should change immediately.

Remember, if gaps in the record appear, turn the paper speed down until a solid record is achieved. The paper speed may also be slowed when not looking for fish or to simply conserve paper. If heavy printing, or "overstrike" occurs, turn the paper speed up. Overstrike happens when the paper moves too slow past the stylus, which causes the stylus to print over a large portion of the previous mark. This makes heavy, black marks on the chart paper. Usually, the easiest way to solve this problem is to turn the paper speed up. However, Alternate Transmit and Print or the Paper Save function listed in the Advanced Operation section in this manual, may help also.

GRAYLINE CONTROL

The GRAYLINE function can be

used to outline the bottom contour which might otherwise be hidden beneath trees and brush; it can also give clues to the composition of the bottom. A hard bottom returns a very strong signal causing a wide gray line. A soft, muddy or weedy bottom returns a weaker signal which is emphasized with a narrow gray line. Do not advance the control too far or it will gray line on the target completely, showing no black, which makes the target difficult to see.

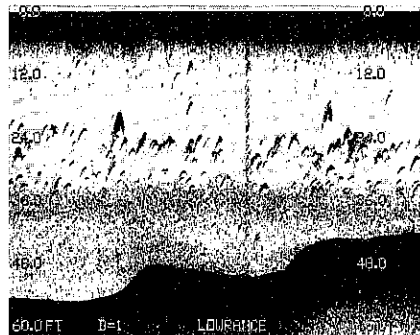

FIGURE 9 GRAYLINE "OFF"

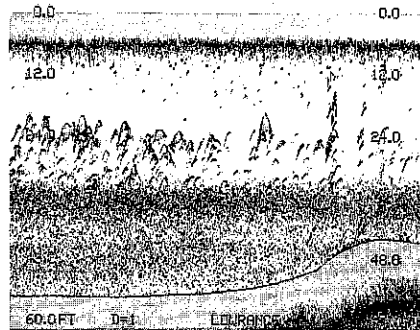

FIGURE 10 GRAYLINE "ON"

RANGE

The range function utilizes the keyboard to select any range between 0 and 8000' in 1 foot increments. Please read this section carefully to get the most out of the X-16's range capabilities.

LOWER LIMIT

When you first turn on the X-16, the range will be 0-60 feet.

To change to a deeper range, simply press the desired depth on the keyboard, and then press the LOWER LIMIT key.

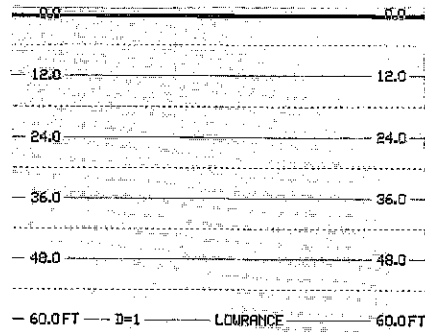

FIGURE 11

Example: Change range to 0-75 feet.

Press: 7 - 5 - LOWER LIMIT

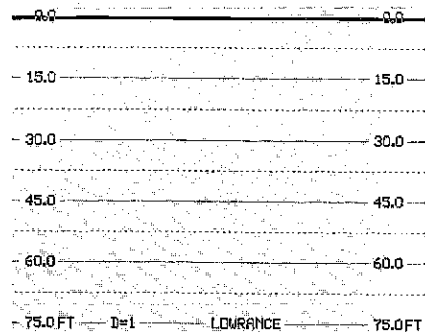

FIGURE 12

NOTE: Remember, any depth may be used as a lower limit displayed at the bottom of the chart paper.

Example: Change range to 0-256 feet.

Press: 2 - 5 - 6 - LOWER LIMIT

Note that the paper speed slows automatically at this range setting.

down to a minimum when looking for fish.

However, it is helpful sometimes to have longer pulse width when resolution is not a concern. When using a sonar in deeper water, it is easier for the unit to detect a longer pulse coming back from the bottom or from fish. This is called "Probability of Echo Detection". The probability of the unit being able to detect an echo returning from deep water is diminished because the further the sound pulse has to travel, the weaker it becomes. By broadening the pulse length, in essence, a larger signal is transmitted and it is easier for the receiver to detect it.

For this reason, the micro-computer in the X-16 automatically increases the initial pulse length of the unit as deeper lower limits are set by the operator. (Note: Initial pulse length is the pulse length of the unit when the Suppressor control is set to minimum.)

length from 600 - 879 feet is the depth plus 4 micro-seconds (μs) per foot **OVER** 600 feet. In other words, with a lower limit of 700 feet, the initial transmit pulse length would be 1100 micro-seconds.

The transmit pulse length can be increased from the initial point at any time by using the Suppressor control. The maximum amount of pulse length added to the initial transmitter pulse length is approximately 800 micro-seconds. In other words, if the LOWER LIMIT is set to 420 feet, and the Suppressor control is increased to the maximum, (press 7 - 2nd - 9) the transmitter pulse length would be 1220 micro-seconds. (420 initial + 800 = 1220.)

The amount that the initial transmit pulse length is increased with suppression is listed in the following chart. Remember, the number in the right hand column

LOWER LIMIT (feet)	INITIAL TRANSMIT PULSE WIDTH (micro-seconds)
1 - 19	110
20 - 29	130
30 - 199	160
200 - 599	Same as LOWER LIMIT
600 - 879	Same as LOWER LIMIT + $4\mu\text{s}/\text{ft}$ over 600'
880 - maximum	1700 μs

From 200 feet to 599 feet, the initial pulse length increases at the same rate as the depth. For example, with the LOWER LIMIT set to 260 feet, the initial transmit pulse length would be 260 μs . If the LOWER LIMIT is set to 390 feet, the initial transmit pulse would be 390 μs . The pulse

is the amount added to the initial transmit pulse length.

When Suppressor level "0" is chosen, the suppressor level is automatic. This ties in with the Discrimination feature. As different levels of Discrimination are selected, and the Suppressor level is set to "0", the suppression level



FIGURE 40

graph record becomes coarse and the ability to separate fish from the bottom or from other fish will be decreased. (See Figure 41 & 42.) Therefore, the lower the suppression setting, the better. Increase the Suppressor setting only as far as necessary to remove the erratic, unwanted noise marks. Most of the time at low or trolling speeds, no suppression will be necessary.

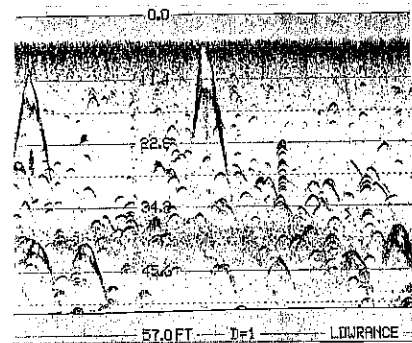

FIGURE 41 PROPER SETTING

To use the Suppressor, simply press the desired amount of suppression desired, from 0 to 7, and then press the 2nd key and the 9 key. For example, if you wanted to increase the suppression level to 5, then you would press: 5 - 2nd - 9, in that order. When any Suppressor level

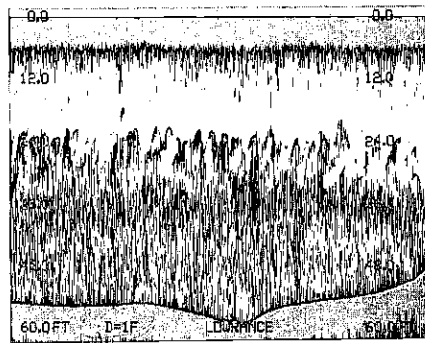

FIGURE 42 SUPPRESSION: TOO HIGH

other than 0 is chosen, the level is printed on the bottom line of the chart paper. For example, if the suppressor level is set to 5, then the X-16 will print: SUP=5.

The only disadvantage to this system is that resolution, or the ability to separate targets, is diminished when the pulse length is increased. A 200 μ s (micro-second) transmitter pulse length used on the X-16 when power is first turned on, will allow the unit to display two fish or targets that are only 6 inches apart. In other words, if two fish that are 6 inches apart are displayed on the graph paper, they will show up as two separate arches when the transmitter is operating with a 200 μ s pulse length. Now, if we increase the transmitter's pulse length to 400 μ s, (by increasing the Suppressor) those same two fish arches will blend together and show up as one fish or possibly even a "blob" on the paper.

With a 400 μ s transmit pulse width, those same two fish will have to be at least 12 inches apart before they will show up as two separate arches on the graph. This is why it is important to leave the Suppressor control turned

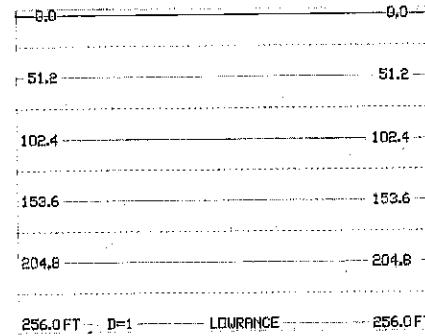

FIGURE 13

UPPER LIMIT

Many times it is desirable to expand a section of the area that is displayed on the graph recorder to show more detail. This is made possible by the X-16 to show segments of the underwater world by using the UPPER LIMIT function. Using the UPPER LIMIT key allows you to display any depth range at the top of the chart paper.

Example: Turn on unit and set range to 20 - 60 feet.

Press: 2 - 0 - UPPER LIMIT

Press: 6 - 0 - LOWER LIMIT

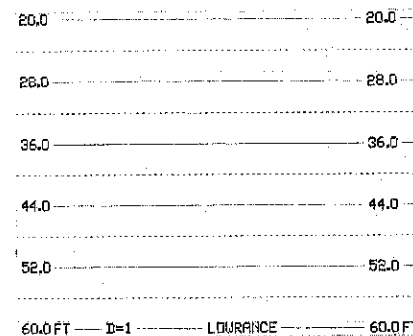

FIGURE 14

Example: Set range to 45 - 72 feet.

Press: 4 - 5 - UPPER LIMIT

Press: 7 - 2 - LOWER LIMIT

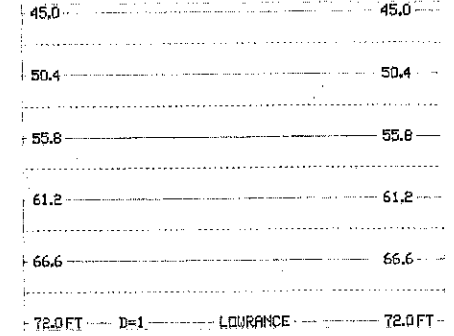

FIGURE 15

The Upper and Lower Limits can be used in various combinations to show segments from the surface to the bottom and anywhere in between. A one foot segment of the depth can be displayed at any time, if desired. Representative samples of chart paper are shown in the back of this manual.

If you wish to display your depth settings at any time, simply press the 2nd key and then the SCALE key. The current range will be printed on the paper immediately. This will not change the depth setting.

NOTE: Although the maximum lower limit of the depth range is 8000 feet, the actual depth that the X-16 will reach is dependent on water conditions, bottom conditions, and the quality of the transducer installation. Typically, the X-16 will reach a depth of approximately 1000 feet without a power booster. You may get more or less depending on conditions.

LINES

When the X-16 is first turned on, depth lines will be printed on the paper. If you desire to turn the Lines off, press the LINES key. To turn the lines back on, press the LINES key again.

Example: Turn lines off:

Press: LINES key

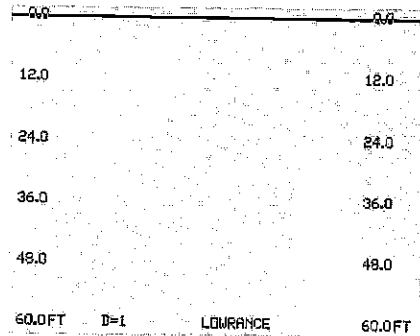

FIGURE 16

MARKER

An event marker function is included in the X-16 so that events may be marked when desired. To use the marker, simply press the MARK key and a vertical line will be displayed across the entire page. Hold the MARK key down and a vertical line will be printed for as long as the key is held down.

Example:

Press: MARK

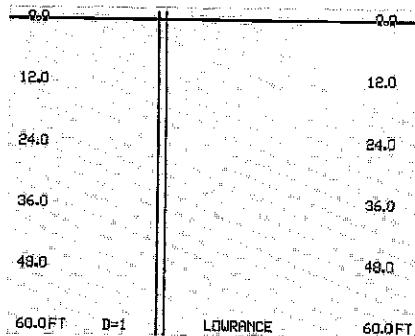

FIGURE 17

SCALE

The numbers that indicate the depth or scale may be deleted if desired. Pressing the SCALE key once will stop the printing of the

scale numbers. The scale may be displayed again by pressing the SCALE key.

Remember, the scale may be displayed at any time by pressing the 2nd key and then the SCALE key.

Example:

Press: SCALE

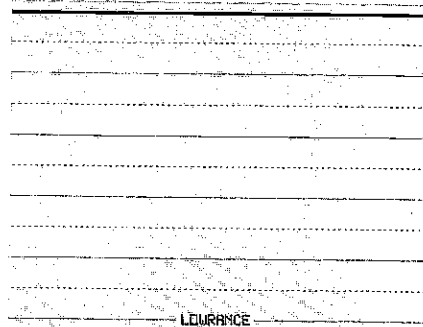

FIGURE 18

MEMORY/RESET

The Lowrance X-16 has an internal battery that keeps power supplied to the memory circuits even when the power switch is turned off. The power cable may be unplugged from the unit and the X-16 will still remember the last settings that were in effect when the unit was turned off or removed from the boat. To reset the X-16's functions to their factory settings, turn the unit on and press the 2nd key and then press the MARK key. The unit will then be set up as follows:

FUNCTION	LEVEL
RANGE	0-60 FEET
DISCRIMINATION ..	1
PULSE WIDTH	0 (automatic)
SUPPRESSION	0 (automatic)
PRINT INTENSITY .	1
PAPER SPEED	5
SCC	0
PAPER SAVE	0

The SCC control tracks the lower limit depth range and works on the upper 60% of the chosen range, with zero always being the upper limit, regardless of the upper limit displayed on the paper. The maximum effective depth for SCC is 255 feet.

The effect on surface clutter should immediately be seen. Use only the amount of SCC required to reduce the clutter, as fish signals can be eliminated by using this method, also.

If you wish to turn the SCC function OFF, simply press 0 - SCC and the SCC function will be disabled.

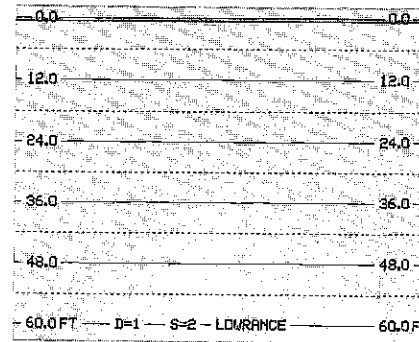

FIGURE 38

SCC: 2

SUPPRESSOR

The Suppressor is a noise suppression system consisting of a patented pulse length discrimination suppression circuit. It is the same as the one used on all Lowrance variable suppression flashers and graphs. Basically, it works on the principle that most noise pulses are of relatively short duration. If the receiver circuit can be adjusted so that it will accept only long pulses, then the short pulses will be cancelled out, and only the desired information (fish, bottom, structure, etc.) will be displayed. Of course, the

transmitter's pulse length would have to be increased at the same time so that the return echoes would be accepted by the receiver.

This is exactly what the Lowrance suppression system does. The transmitter's pulse length is increased by using the keyboard, and the receiver "tracks" the amount of increased pulse length, cancelling out any narrow noise pulses, and displaying only the return echoes from fish or the bottom, etc. (Note: receiver sensitivity is not diminished at all by this process.)

Noise, in electronic terms, is any undesired signal. It can be caused by an electrical source, (such as the engine's ignition system) or by air bubbles in disturbed water which is called cavitation. In both cases, the noise could produce unwanted marks on the paper. (See Figures 39 & 40.) Fortunately, noise pulses are relatively short in time compared to real sonar signals. Increasing the Suppression will cause the

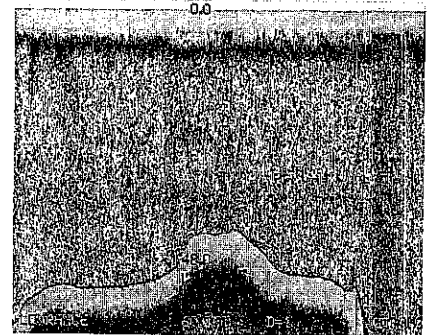

FIGURE 39

system to reject these unwanted, short pulses without reducing the sensitivity in any way.

This patented design is exclusive with Lowrance. However, with high suppression settings, the

washed periodically with mild soapy water to remove any accumulated road grime or oily film. This is essential to have good contact between the transducer and the water.

Periodically, the rubber roller on the paper drive should be cleaned with a cloth dampened with alcohol to improve the friction on the metering roller drive.

Don't open the case or the transport assembly when the unit is running. The stylus holder and stylus may be damaged or personal injury may result.

TROUBLESHOOTING

Symptom

On/Off switch is "ON", but the stylus and paper don't move

On/Off switch is "ON", have zero mark, but no bottom signal or echoes.

The unit works properly when stopped or at slow speeds, but loses the bottom signal at high speed, or makes heavy black lines.

Blank spots in record.

Paper stops pulling.

fish signals or other targets. This is called Surface Clutter and is caused by algae and plankton, air bubbles caused by wave action or boat wakes, bait fish, or temperature inversions.

The surface clutter markings can be reduced or eliminated by using the SCC control key on the front panel keyboard.

To use the SCC, press key 1 thru 7 (depending upon the amount of SCC desired) and then the SCC key. 1 has a minimum effect on surface clutter, 7 has the maximum effect on reducing

What To Do

Check fuse; check connections at battery for tightness and corrosion.

Be sure the transducer is plugged into the unit and the transducer is making contact with the water.

Transducer is improperly installed. Read transducer installation instructions for the correct mounting procedure.

Stylus is "skipping" over areas of the chart paper. Readjust stylus according to the diagram on page ?. If this does not help, replace stylus.

Check paper for binding or improper tracking. Straighten the paper and retape it squarely onto the take-up paper core.

POWER BOOSTER OFF
ALTERNATE TRANSMIT &
PRINT OFF
LINES ON
SCALES ON
FREQUENCY
CONVERTER OFF
BATTERY BACKUP ON

If you do not recognize some of the functions listed above, look in the Advanced Operation section of this manual for more instructions.

The Memory function can be turned on or off as desired. When the Memory function is turned off, only the depth mode (Feet, Fathoms, or Meters) will be retained.

To turn the Memory function off, press 11 - 2nd - 5.

To turn the Memory function on, press 10 - 2nd - 5.

FEET, FATHOMS, METERS

The X-16 will display the depth in feet, fathoms, or meters. Although the unit will revert back to the feet mode whenever the 2nd - MARK feature is used (see above), it is simple to change to any mode you wish by pressing the 2nd key and then 1 for feet, 2nd - 2 for fathoms, and 2nd - 3 for meters.

When the unit is in the Feet mode, the letters "FT" will be displayed next to the lower limit depth scale. In the Fathom mode, the letters "FA" will be displayed, and the letter "M" will be displayed when the unit is in the meters mode.

Example: Display Fathoms

Press: 2nd - 2

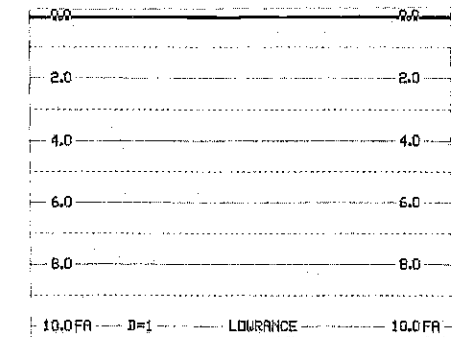

FIGURE 19

By looking at the lower limit scale printed on the chart paper, one can determine if the unit is in feet (FT), fathoms (FA), or meters (M). The unit can be switched from one mode to another at any time.

END-OF-PAPER MARKER

The graph paper used in the X-16 has a red line printed at the bottom of the paper to signify when there is only 2 to 3 feet before the end of the paper.

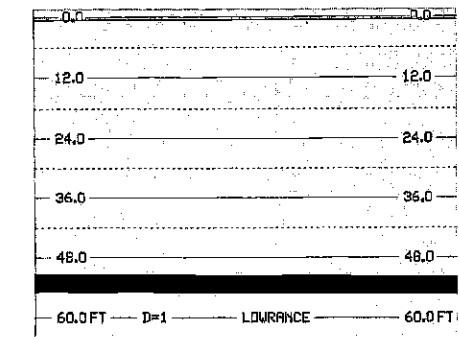

FIGURE 20

ZERO ADJUST

Occasionally, when changing the stylus or stylus belt, the zero line does not print at the same

ADVANCED OPERATION

Surface Clarity Control (SCC)

The surface markings at the top of the chart paper can, at times, extend many feet below the surface. This often interferes with

surface clutter. 2 thru 6 have intermediate effects. The amount of SCC that is used is printed at the bottom of the chart paper. If one level of SCC is used, then SCC-1 is printed. Two levels, SCC-2, etc.

place near the top of the chart paper. A zero adjust control has been placed on the back inside wall of the X-16 near the upper left hand corner so that the zero line position may be adjusted on the paper.

Open the case front and look for the decal marked "ZERO ADJUST". You may have to pull the paper transport assembly down to see the decal for the first time. Push the transport closed and turn on the unit. (**CAUTION** — Keep hands away from the stylus belt and stylus. High voltage is present.)

Insert a 6-8" long screwdriver with a 1/8" blade into the zero adjust hole and rotate the control until the zero line is at the desired position. (Note: this may also be adjusted with the unit turned OFF.) Adjust the control, then remove the screwdriver and turn power back ON. Repeat until the zero line is in the desired position.

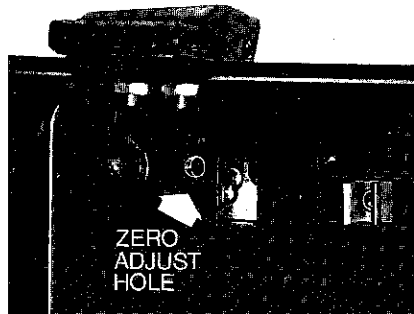

FIGURE 21

IV HOW TO READ GRAPHS

"Arched Signatures"

A remarkable advantage of the X-16 is that it can record individual fish with a characteristic arched mark that separates them from their stationary surroundings. The

reason for this is shown on page 10. (The distance to a fish when it moves into the sonar's cone of sound is shown as "A" in Figure 22). When the fish has moved to the center of the cone, the distance to it will be shorter, (line "B"), and as it moves out of the cone, the distance will increase again as shown in line "C".

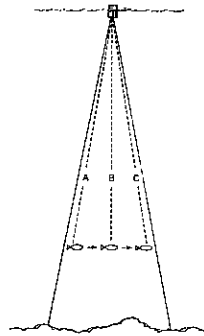

FIGURE 22

If a partial arch occurs most of the time on your unit, (the mark curves up, but not back down, or vice-versa) it is because the transducer is not pointed straight down. If your transducer is mounted on the transom, adjust the transducer until the fish show the distinctive arched signature. This may take some trial and error until the correct mounting is achieved.

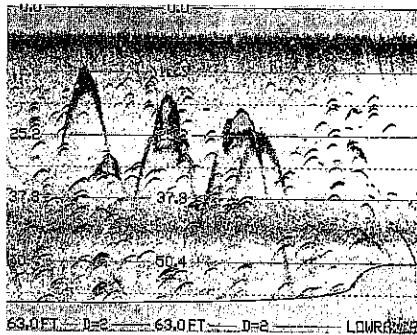

FIGURE 23

- Close the front of the case. Latch both catches on the top of the case.

STYLUS BELT REPLACEMENT

CAUTION — High voltage is present in the electronic section when the unit is turned on.

- TURN THE UNIT OFF.
- Release both catches on the top of the case. Pull out and down on the top of the case front and the platen to expose the stylus belt.
- The stylus belt rides over two pulleys located at the right edge of the transport assembly. Move the front of the belt DOWN to position the stylus at the center of the platen.
- Grasp the belt at the stylus holder with the thumb and forefinger and move it gently to the left while pushing the belt off the pulleys with the other finger. (See Figure 37.)



FIGURE 37

- Position the new belt on the pulleys by reversing the procedure used to remove the old one. BE SURE the fingers of

the new stylus are pointed UP.

- Close the front of the case. Latch both catches at the top of the unit.

MAINTENANCE

Remember, the stylus may be damaged if it is in front of the platen when the transport assembly is pulled down. **Always** move the stylus to the back side of the transport assembly when changing the paper. The stylus belt should be rotated down to remove the stylus. Never rotate the stylus belt up.

Black carbon dust is created during the recording process. Use a soft, oil-free rag to clean the viewing door and transport assembly. Low pressure compressed air may be used to blow dust out of the case and away from moving parts if the air is dry and free of oil.

After every five rolls of paper, the stylus belt and pulleys it rides on should be wiped clean with a soft rag moistened with alcohol to remove carbon dust.

All mechanical connections should be checked periodically to be sure they haven't worked loose.

Do not apply any type of lubricant to the motors or gear trains.

High voltage is present in the transmitter section when the unit is on. No attempt should be made by any unauthorized person to modify or repair the electronic section.

If corrosion should occur at the power plug, fuse holder, power cord splices, or battery connections, clean as required and check to make sure that good contact is being made at all terminations.

The face of the transducer, if exposed to the water, should be

10. Push the transport assembly back to its operating position. Be sure it engages the catch inside the case.
11. Close the front of the case. Latch both catches on the top.
12. Turn the unit on. Move the Chart Speed knob fully clockwise. Watch the paper long enough to be sure it is moving smoothly and evenly across the platen. If the paper flutters or begins to run "uphill", repeat step 8.

STYLUS REPLACEMENT

CAUTION — High voltage is present in the electronic section when the unit is turned on.

1. **TURN THE UNIT OFF.**
2. Release both catches on the top of the case. Pull out and down on the top of the case front to expose the stylus belt. (See Figure 24).
3. The stylus belt rides over two pulleys located at the right edge of the transport assembly. Move the front of the belt **DOWN** to position the stylus at the center of the platen.
4. Hold the stylus belt stationary with one finger, and remove the old stylus by starting at its left edge and moving it out from under the tabs on the stylus holder.
5. Before installing the new stylus,

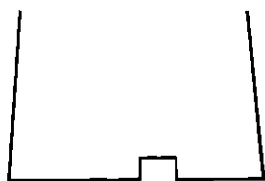

FIGURE 34

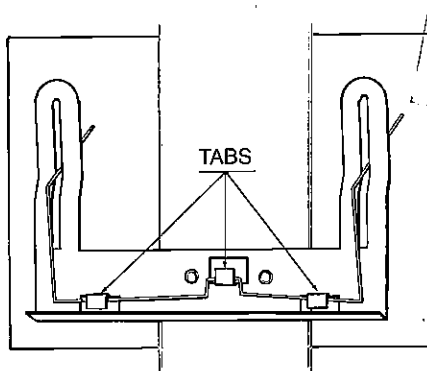

FIGURE 35

be sure it is bent properly by comparing it to Figure 34.

6. Refer to Figure 35 to be sure the new stylus is positioned correctly under the tabs on the holder. Be sure it moves freely in the two slots. If not, bend the stylus away from the edge it is rubbing on until it does move freely.

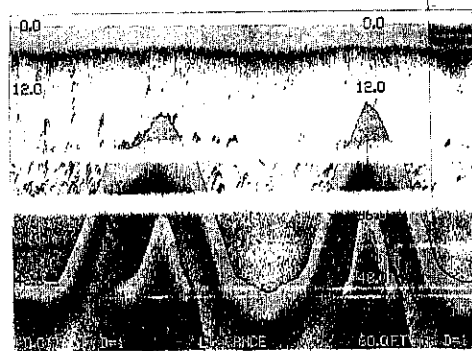

FIGURE 36

7. After installing, if the stylus won't print all the way down the paper as shown in Figure 36, bend the right leg down so that more pressure is exerted against the stainless steel plate. If it still does not print all the way, bend the left leg down more, but not so far that it digs into the paper.

Sharp, well defined signatures will occur most often when the Sensitivity knob is set at the $\frac{3}{4}$ point, or higher. Remember, that there must be some movement between the boat and the fish to develop the arched mark. Usually this means trolling at very slow speeds with the main engine in gear at minimum throttle setting.

THERMOCLINES

The temperature of water in the lake is seldom constant from top to bottom. Layers of different temperatures form, and the junction of a warm and cool layer of water is called a thermocline. (See Figure 23) The depth and thickness of the thermocline can vary with the season or time of day. In deep lakes there may be two or more, at different depths. Thermoclines are important to the fisherman because they are areas where fish are active. Many times bait fish will be above the thermocline while larger game fish suspend just below it.

Your Lowrance X-16 can detect this invisible layer in the water, but the Sensitivity knob will probably have to be set at the $\frac{1}{2}$ point, or higher.

PAPER LOADING

NOTE: There are many imitators manufacturing chart paper that is inferior to ours. Use only Lowrance LPG-605 or LPG-606 chart paper in your X-16.

NOTE — A stylus is enclosed with every package of LPG-606 chart paper. For best results, install the new stylus every other time a roll of chart paper is changed.

CAUTION — High voltage is present in the electronic section when the unit is turned on.

1. **TURN THE UNIT OFF.**
2. Release both catches on the top of the case. Pull out and down on the top of the case front to expose the platen assembly. (See Figure 24).

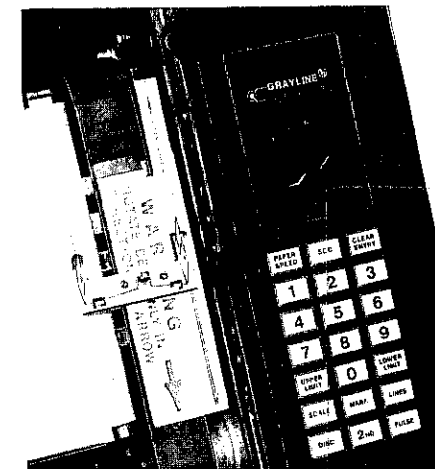

FIGURE 24

3. Move the stylus bolt **DOWN**, to position the marking stylus on the back side of the platen. **NEVER** move the belt up — it could damage the stylus. (See Figure 25).

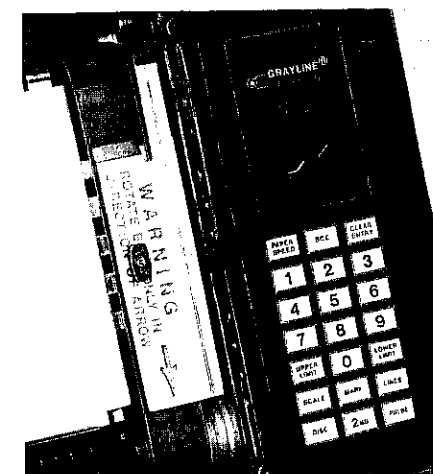

FIGURE 25

Special Note: The stylus may be damaged if the transport assembly is pulled down unless the stylus has been moved to the back side of the platen.

4. Pull out and down on the tab at the top center of the platen assembly to expose the paper spools. (See Figure 26).



FIGURE 26

5. To remove the full take-up roll and the empty supply spool, press the two metal tabs together on the top of the transport assembly, and pull out and down on the paper retainer. (See Figure 24). The full take-up roll can now be easily removed from the paper core shafts. (See Figure 27).

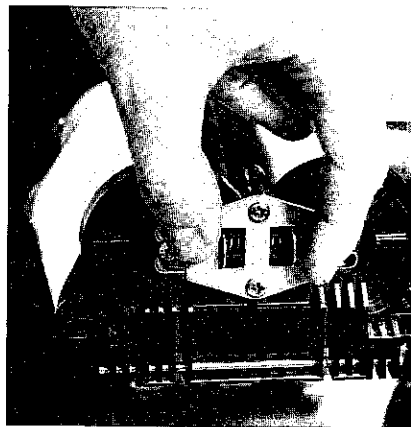

FIGURE 27



FIGURE 28

6. Pull the empty supply core from the right side in the same manner. Install the empty core onto the take-up shaft. (See Figure 29). Align the two notches in the core with the tabs on the lower take-up spool.

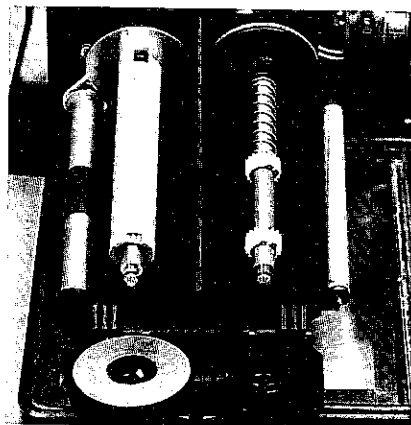

FIGURE 29

7. Slide a fresh roll of Lowrance chart paper in position on the supply side shaft on the right side of the platen assembly. The paper must spool off the bottom of the roll. (See Figure 30).

NOTE: Use Lowrance LPG-605 or LPG-606 chart paper only.

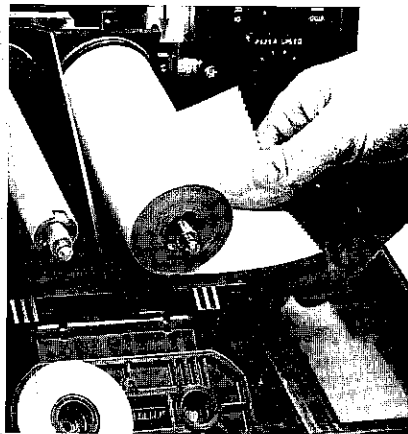

FIGURE 30

8. Draw the end of the paper across the face of the platen, around the friction roller, over the take-up core, and tape it squarely to the take-up core. (See Figure 31). Small pieces

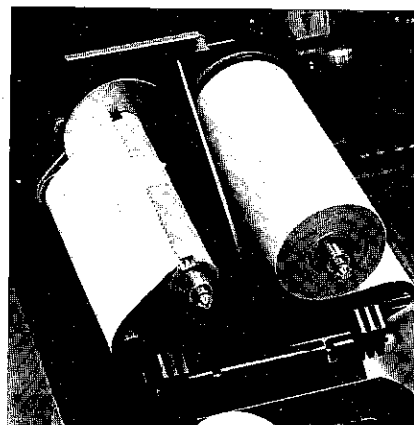

FIGURE 31

of tape may be stored inside the housing for this purpose. Close the top of the transport assembly by pressing the two tabs together on the paper retainer and returning the retainer back to the operating position. (See Figure 32.)



FIGURE 32

9. Turn the small knob at the upper left hand side of the transport assembly to put a small amount of tension on the paper. It should be snug against the platen. (See Figure 33.)

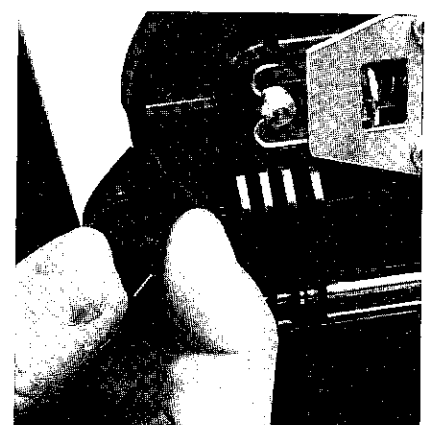

FIGURE 33